

MaterMacc

EN



PRODUCTS CATALOGUE

Seed drills for cereals

MATERMACC FITS YOUR NEEDS

Innovation at your service

For MaterMacc innovation means experimentation, design, building and testing, the fundamental elements which characterize the development of new products. MaterMacc was established in the early 1980's and still bases its research and development on close collaboration with the operators who, year after year, place their trust in us



No matter how you run your farm, MaterMacc offers you the right equipment.

Mankind has been farming for more than 10.000 years and since the industrial revolution it has become accustomed to working the land in a way where the soil is intensively tilled to prepare the seed bed (conventional farming).

However, especially for winter cereals, an alternative farming practice aimed at reducing the number of field operations in favour of soil health and at the reduction of production costs (minimum tillage) has been gaining ground in recent decades. More recently, a growing number of farmers are recognising the value of an even more conservative approach that aims to limit field inputs to seeding, fertilising, weeding and harvesting operations while eliminating ploughing and harrowing for seedbed preparation (No-Till).

MaterMacc is proud to be able to offer seeding machines suitable for use in conventional agriculture, minimum tillage or conservation agriculture (No-Till), meeting the needs of any type of farmer.



Conventional agriculture

**GRANO
GRANO-F**



MSD



MSD ELEKTRO



MSD FTC



Minimum tillage

**GRANO-X
GRANO-XF**



MSD ELEKTRO



MSD FTC



MSD COMBI



MSD COMBI FOLDING

UST



No-till drilling

UST

SEED DRILLS FOR CEREALS

Be precise when drilling cereals too!

Recognised for the undisputed quality of its precision seeders, MaterMacc has now also established itself in the field of mechanical and pneumatic seeders for seeding in rows on tilled, SEED-tilled or no-tilled soil.



UST

Pneumatic seed drills minimum till & no-till - *Unique*

High performance pneumatic seed-drill geared toward conservative agriculture techniques. The foldable frame allows for low road transport width with working widths of 4.5 and 6.0 m.



GRANO / GRANO-X

Mechanical seed drills - *Simple and reliable*

GRANO is available with suffolk, single or double disc coulters.

GRANO-X mounts an aggressive point share coulters or single disc, ideal to work on minimally prepared soil.

MSD

Pneumatic seed drills - *Greater productivity and precision*

Available with working width spanning from 4.0 to 6.0 m all with foldable tool bar.



AGRICULTURE 4.0 READY

Look for the logo above to recognize which models comply with Agriculture 4.0 standards.



MSD 2.0 Pneumatic seed drills - *Hi-tech seeding*

MSD ELEKTRO makes good use of the high technological content with which it is equipped to increase even further reliability and productivity as compared to its little sister, MSD.



MSD 2.0 COMBI & FOLDING Seed drill combined to a power harrow - *Fewer passes, less soil compaction*

By combining the MSD ELEKTRO seed drill with a robust power harrow, you can do two jobs in one go. Available in working widths from 3.0 to 6.0 m with fixed or folding frame and front seed tank.

MECHANICAL SEED DRILLS

GRANO



Seed covering harrow (OPTIONAL).

Row marker
Hydraulic row marker (OPTIONAL).

Available planting units



Suffolk coulters.



Disc coulters with depth control.



Double disc coulters.



Double disc coulters with seed pressing wheel.

MECHANICAL SEED DRILLS FOR CEREALS



Step-less CVT gearbox with seeding rate test handle.



Centralized coulters adjustment.



Half of the working width can be mechanically excluded.



Loading platform with step ladder.

Wheels

Standard drive wheels 6.50x15",
optional drive wheels 26.00x12".

Optional



Seeding depth limiter for rice.

GRANO Mechanical seed drills for cereals

Mechanical drill machine for cereals, rapeseed, soy, lucerne and other forage in rows on prepared soil.

This is a compact drill machine, and has a working width from 2.5 m to 4.0 m.



MODEL	N° OF ROWS	ROW SPACING	TOOL BAR	WEIGHT			POWER REQUIRED	CAPACITY		PRODUCTIVITY
				COULTER	DISC	DOUBLE DISC		SEED	FERTILIZER	
		(cm)	(cm)	(kg)			(hp)	(L)		(ha/h)
GRANO 250	17	14.7	250	470	540	625	50	610	–	2.0
GRANO 250	19	13.2	250	480	550	645	50	610	–	2.0
GRANO 250	21	12.0	250	490	560	665	70	610	–	2.0
GRANO 300	19	15.8	300	545	625	720	50	750	–	2.4
GRANO 300	21	14.3	300	560	640	745	70	750	–	2.4
GRANO 300	23	13.0	300	575	655	770	70	750	–	2.4
GRANO 300	25	12.0	300	590	670	795	70	750	–	2.4
GRANO 400	29	13.8	400	760	840	985	90	670	–	3.0
GRANO 400	31	12.9	400	775	855	1010	100	670	–	3.0
GRANO 400	33	12.0	400	790	870	1050	100	670	–	3.0



The fluted roller seed distributor has two distinct selectable working elements: one for bigger seeds, one for smaller seeds.

GRANO-F Mechanical seed drills for cereals

Mechanical drill machine for cereals, rapeseed, soy, alfalfa and other forage in rows on prepared soil.

Being able to spread fertilizer while seeding increases the versatility of this compact drill machine.

Working width spans from 2.5 m to 4.0 m.



MODEL	N° OF ROWS	ROW SPACING	TOOL BAR	WEIGHT			POWER REQUIRED	CAPACITY		PRODUCTIVITY
				COULTER	DISC	DOUBLE DISC		SEED	FERTILIZER	
		(cm)	(cm)	(kg)			(hp)	(L)		(ha/h)
GRANO-F 250	17	14.7	250	520	590	675	60	335	280	2.0
GRANO-F 250	19	13.2	250	530	600	695	60	335	280	2.0
GRANO-F 250	21	12.0	250	540	610	715	80	335	280	2.0
GRANO-F 300	19	15.8	300	595	675	770	60	415	345	2.4
GRANO-F 300	21	14.3	300	610	690	795	80	415	345	2.4
GRANO-F 300	23	13.0	300	625	705	820	80	415	345	2.4
GRANO-F 300	25	12.0	300	640	720	845	80	415	345	2.4
GRANO-F 400	29	13.8	400	810	890	1045	100	450	220	3.0
GRANO-F 400	31	12.9	400	825	905	1070	110	450	220	3.0
GRANO-F 400	33	12.0	400	840	920	1095	110	450	220	3.0

Tank

The inside of the hopper has two distinct sections for seed and fertilizer to prevent them from mixing before reaching the drop pipe.



Seed hopper.

Fertilizer tank.

Additional variator for fertiliser or minute seeds.

Using dedicated dispensers for each tank, it is even easier to accurately determine the floristic composition of your mixture.



A simple guillotine mechanism allows the selection of suitable fluted rollers for use with large or small seeds. The practical transparent cover ensures that the dispensers are working properly by protecting them from dust, sand or other contaminants.

MECHANICAL SEED DRILLS

GRANO-X



Half of the working width can be mechanically excluded.

Straight seed covering spring down pressure and inclination can both be adjusted.

Available planting units



Share tine coulter.



Disc coulter with depth control.

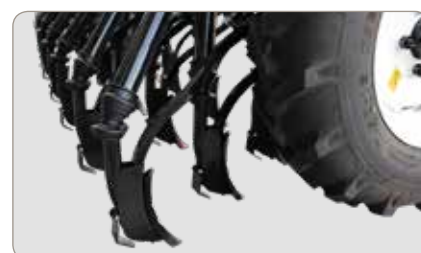

The seeding elements are placed on three rows.

MECHANICAL SEED DRILLS FOR CEREALS

One metering unit for all seed types

The fluted roller seed distributor has two distinct selectable working elements for small seeds. The fluted rollers are shielded from dust by a transparent window that allows to monitor working performances.



Sprockets for large seeds.

Single sprocket for very small seeds.

Transmission

A contact wheel transmits the motion to the distributors.



Wheels

Standard drive wheels 7.50x16".

Towed version (Optional)

The machine can be towed thanks to the reversible drawbar both during work or during transport.



GRANO-X Mechanical seed drills for cereals

Mechanical drill machine for cereals, rapeseed, soy, lucerne and other forage in rows. This is a compact drill machine with a 3.0 m working width that does not necessarily need heavily worked soil to perform properly.



MODEL	N° OF ROWS	ROW SPACING		TOOLBAR	WEIGHT		REQUIRED POWER	CAPACITY		PRODUCTIVITY
		SHARE TINE	DISC		SHARE TINE	DISC		SEED	FERTILIZER	
		(cm)		(cm)	(kg)		(hp)	(L)		(ha/h)
GRANO-X 300	20	14.9	14.5	320	940	1075	50	705	-	2.7
GRANO-X 300	21	14.2	13.8	320	948	1090	70	705	-	2.7
GRANO-X 300	23	12.9	-	320	962	-	70	705	-	2.7
GRANO-X 300	25	11.8	-	320	976	-	90	705	-	2.7



Mounted version (Standard).
Seeding depth is adjusted mechanically.



Towed version (Optional)

Two hydraulic actuators lift the machine from the ground to protect the seeding elements during transport and turns. Seeding depth is also adjusted hydraulically.



GRANO-XF Mechanical seed drills for cereals

Mechanical drill machine for cereals, rapeseed, soy, lucerne and other forage in rows on lightly worked soil.

This is a compact drill machine, and has a effective working width of 3.0 m.

Being able to spread fertilizer while seeding increases the versatility of this product.



MODEL	N° OF ROWS	ROW SPACING		TOOLBAR	WEIGHT		REQUIRED POWER	CAPACITY		PRODUCTIVITY
		SHARE TINE	DISC		SHARE TINE	DISC		SEED	FERTILIZER	
		(cm)		(cm)	(kg)		(hp)	(L)		(ha/h)
GRANO-XF 300	20	14.9	14.5	320	940	1075	50	390	315	2.7
GRANO-XF 300	21	14.2	13.8	320	948	1090	70	390	315	2.7
GRANO-XF 300	23	12.9	-	320	962	-	70	390	315	2.7
GRANO-XF 300	25	11.8	-	320	976	-	90	390	315	2.7

Tank

The inside of the hopper has two distinct sections for seed and fertilizer so that they won't mix before reaching the drop pipe.



Fertilizer tank.

Seed hopper.

Additional variator for fertilizer or small seeds.

The two separated hopper sections and double distributor can also be used to seed mixes of seeds with different dimensions ensuring the most precise composition of your mix.



A simple guillotine mechanism allows the selection of suitable fluted rollers for use with large or small seeds. The practical transparent cover ensures that the dispensers are working properly by protecting them from dust, sand or other contaminants.



PNEUMATIC SEED DRILLS MSD

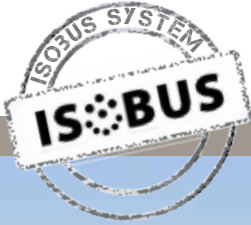

Row marker
Hydraulic row marker.



Distribution heads
Pneumatic transportation and distribution head for an even distribution of the seed.

Loading platform with handrail.

Planting units



Disc coulters with depth control.

Accessories



Seeding depth limiter for rice.

Seed tank

Large tank 1000 L, with four metering units.
500L tank extension available as optional.

LED transport lights and reflection panels.



Wheels

26.00x12" drive wheels.

Variator

Step-less speed gearbox.



Metering unit

Each seed drill mounts 4 pneumatic seed distributors, each connected to its own distribution head (X4 seed monitor OPTIONAL).



Cut of device

Each seed distributor can be excluded from the driving seat. Electromechanical exclusion of the 4 metering units is OPTIONAL.



Small seeds metering unit

This tank holds 140L and can be used both for small seeds or microgranular products (OPTIONAL).

MSD Pneumatic seed drills for cereals

Pneumatic seed drill for sowing cereals, rapeseed, soy, alfalfa and other forage in rows on well prepared soil.

The working width ranges from 4.0 m to 6.0 m with a minimal row spacing of 12.5 cm on the standard configuration.

The tool bars folds hydraulically, limiting the transport width to just 254 cm.



MODEL	N° OF ROWS	ROW SPACING	TOOLBAR	WEIGHT	REQUIRED POWER	CAPACITY		PRODUCTIVITY
						SEED	MICRO	
		(cm)		(cm)	(hp)	(L)		(ha/h)
MSD 400	28	14.3	254/400	1120	80	1000	140	3.0
MSD 400	32	12.5	254/400	1160	80	1000	140	3.0
MSD 450	32	14.1	254/450	1190	80	1000	140	3.3
MSD 450	36	12.5	254/450	1230	90	1000	140	3.3
MSD 500	32	15.6	254/500	1230	80	1000	140	3.6
MSD 500	36	13.9	254/500	1270	90	1000	140	3.6
MSD 500	40	12.5	254/500	1310	100	1000	140	3.6
MSD 600	40	15.0	254/600	1410	100	1000	140	4.6
MSD 600	44	13.6	254/600	1450	100	1000	140	4.6
MSD 600	48	12.5	254/600	1490	110	1000	140	4.6





Hydraulic towing device (OPTIONAL)

The hydraulic towing device allows to convert the machine from mounted to towed.
Ideal to work on slopes or with smaller tractors.





PNEUMATIC SEED DRILLS MSD 2.0



ENAMA certified seeder

Seed tank

Large tank 1300 L, with four metering units.

Wheels

Standard drive wheels 26.00x12".

Row marker

Hydraulic row marker.

LED lights

New LED lighting kit

MAGIC DRILL

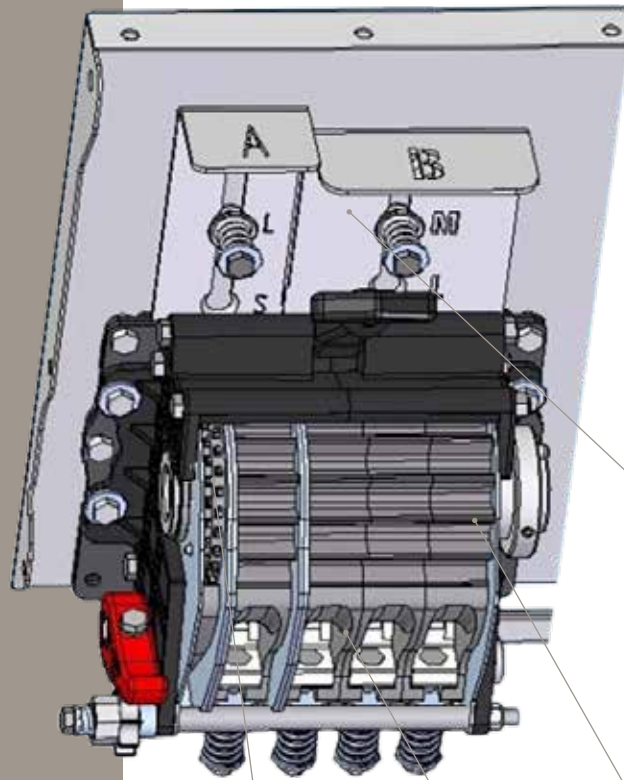

Stainless steel sorting guillotines for small seeds (A) and large seeds (B)

Sprockets for very small seeds.

Adjustable contact fingers.

Sprockets for large seeds.

New metering unit for all seed types

The metering system has been totally re-engineered to ensure optimal performance and more consistent distribution with any kind of seeds. The MagicDrill seed distributor is made up of variable cell fluted rollers that can be used individually, for small seeds, or together reaching seeding rate of 400 kg/ha.

Choosing the most appropriate setting is really easy and requires only a few, simple manual movements.

The 4 distributors can be fully inspected, to optimise and reduce cleaning to a minimum. The sowing test is also easy to carry out, thanks again to the clearance space around the distributors.

Available planting units



Single disc unit with working depth control.



Single disc unit and seed pressing/ depth control wheel.



Double disc unit and seed pressing/ depth control wheel.

Double disc unit with depth gauge wheel

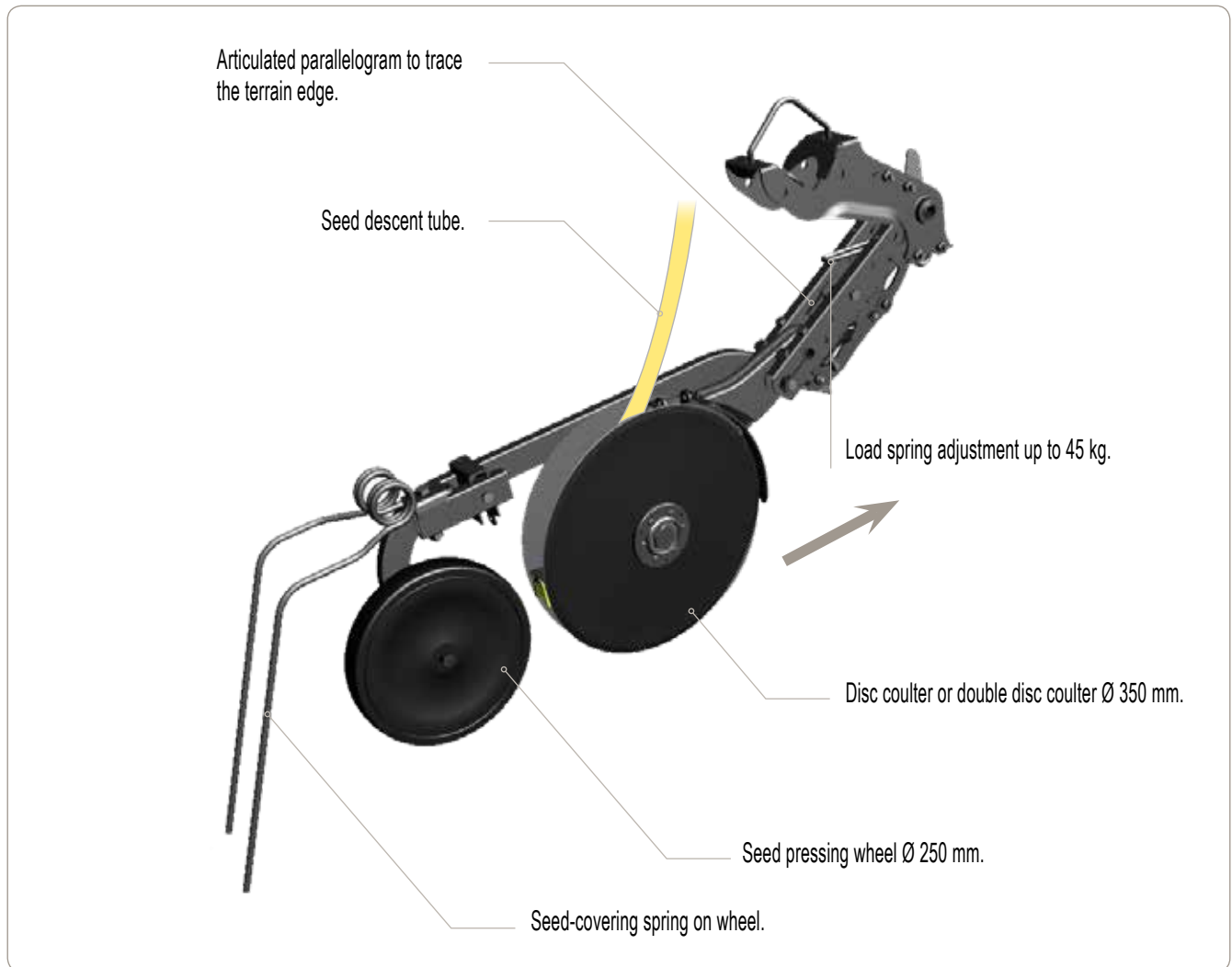

Planting unit

The jointed parallelogram part of the planting unit ensures robust and reliable performance over time, including during intensive use at high sowing speeds.

The down pressure can be adjusted up to 45 kg on each seeding element; this ensures the same sowing depth is maintained constant, even on firm soils.

The seed pressing wheel has the double function of closing the sowing furrow, and to act as a depth control wheel. It can be manually adjusted to adjust the depth of seeding.

Finally, the seed cover adapts to the irregularity of the terrain and covers the seeds evenly.

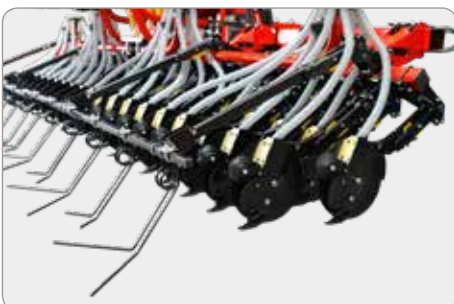

"V" shaped seed-covering spring harrow. Standard on single disc seeding elements is also available on seeding elements with seed-pressing wheel (Optional)



Seed-covering spring on wheel. Only for model with wheel.

Our competitors

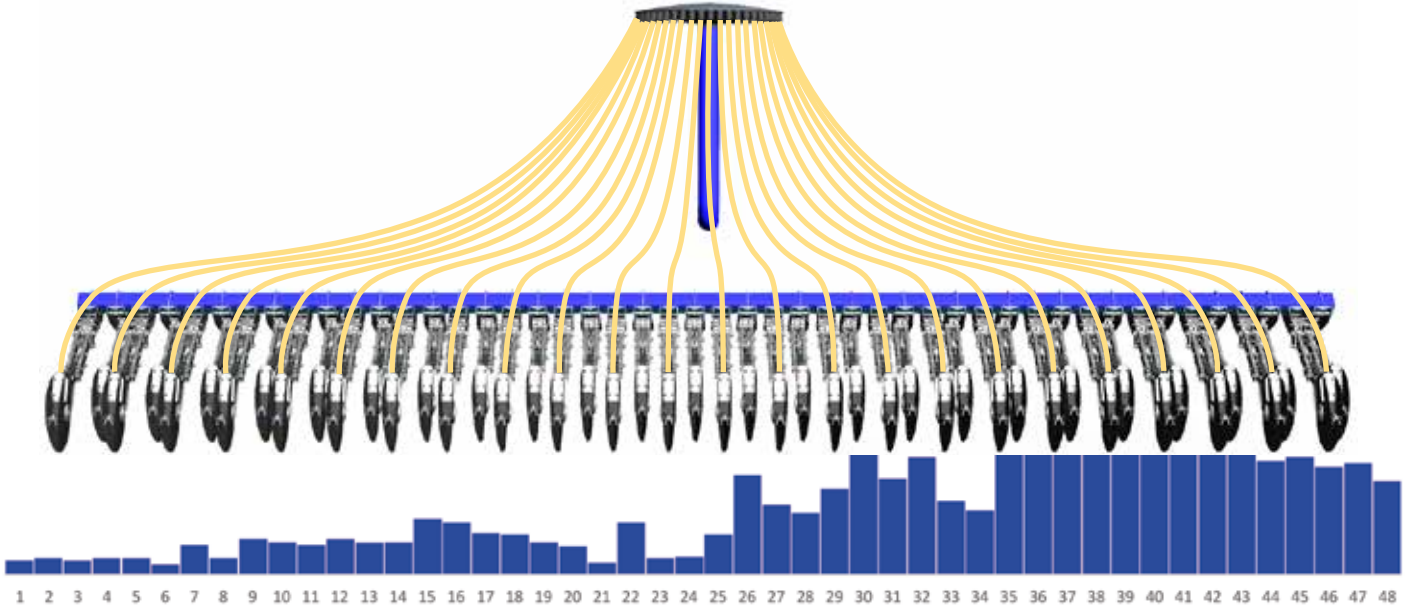

MaterMacc MSD ELEKTRO seed drill

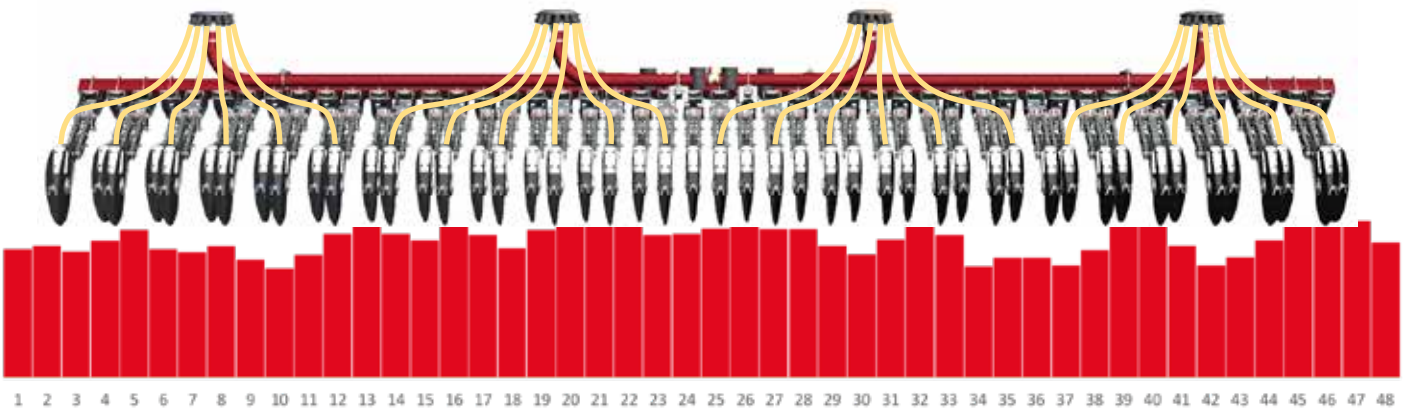

Tested conditions: 5 kg/ha rapeseed; working speed: 12 km/h



■ MSD ELEKTRO
 ■ Competitors
 ■ Theoretical seed rate

Distribution heads

Seed distribution is perfectly divided up between the 4 sowing distributors and 4 mixing heads (6% mean error as compared to the 26% detected testing our competitors). This excellent solution reduces dosing errors to a minimum across the whole operating width. In addition, the 4 sowing sections can be excluded singularly, where there is overlap.

MSD ELEKTRO

Pneumatic seed drills for cereals

Pneumatic seed drill for sowing in tilled or semi-tilled soil for cereals, rapeseed, soy, alfalfa and other forage.
 The working width is 5.0 m and 6.0 m with a standard row distance of 12.5 cm.
 The 4 seed distributors are powered by an electric motor and controlled by the MaterMacc X4 seeding monitor. This monitor allows to quickly adjust the seeding rate, by setting the desired value. It also controls the sowing flow for each of the four sections.
 The tramline and seed exclusion functions are optional and can be integrated with the X4 monitor.



MODEL	N° OF ROWS	ROW SPACING	TOOLBAR	WEIGHT			REQUIRED POWER	CAPACITY SEED	PRODUCTIVITY
				DISC	DISC + PRESS WHEEL	DOUBLE DISC + PRESS WHEEL			
		(cm)	(cm)	(kg)			(hp)	(L)	(ha/h)
MSD ELEKTRO 500	32	15.0	270/500	1440	1630	1690	100	1300	4.4
MSD ELEKTRO 500	36	13.9	270/500	1490	1710	1790	110	1300	4.4
MSD ELEKTRO 500	40	12.5	270/500	1550	1790	1880	120	1300	4.4
MSD ELEKTRO 600	40	15.0	270/600	1560	1800	1920	120	1300	5.6
MSD ELEKTRO 600	44	16.6	270/600	1620	1880	2020	130	1300	5.6
MSD ELEKTRO 600	48	12.5	270/600	1670	1960	2110	130	1300	5.6

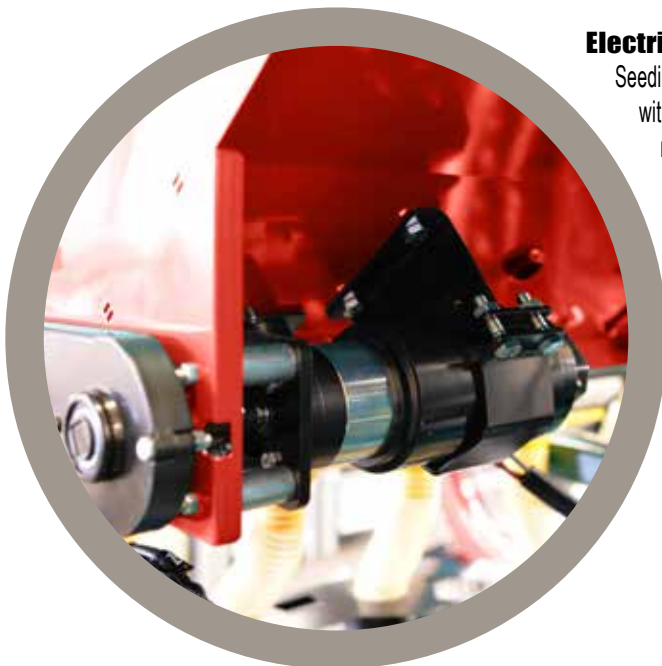

Electrically driven distributors

Seeding rate is managed electronically by the X4 control monitor, supplied as standard with the MSD 2.0 ELEKTRO. The 4 MagicDrill seed distributors are activated by a reliable electric motor, meaning calibration is automatic and the sowing dose can be adjusted while working.

The X4 monitor, in addition to adjusting the seed investment, also functions as hectare counter, it is preconfigured to exclude any of the 4 seeding sections and the tram-line. It also manages independently the PRESTART and PRESTOP function. With this function it is possible to seed perfectly on the entire field surface, right to the outer edge.

Function monitor X4

- Seeding check alarm
- Partial and total hectare counter
- Working speed
- Blower RPM sensor
- Seed level sensor
- Tramline set-up
- Section excluder set-up
- Seeder PRESTART, PRESTOP



standard kit for small seeds (rapeseed)

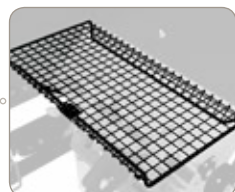

Sifter for small seeds.

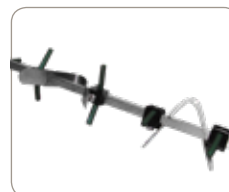

MSD agitators for small seeds.

Optional

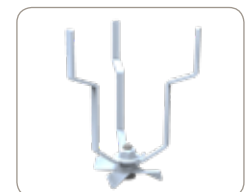

Distribution head mixer impeller.

Row marker not protruding

In its rest position, the row marker on MSD ELEKTRO totally fits within the footprint of the machine.



Tramline

MSD ELEKTRO can mount an automatic tramline system (Optional). By setting the desired working width, the Tramline system automatically recognizes where the tractor is going to transit during spraying/fertilizing passes and excludes 2-3 rows on each side of the carriage way avoiding waste of seed where plants would get damaged anyway being frequently trampled.



You can seed soybean if you want it!

By simply excluding a few drop tubes with a plug, the MSD ELEKTRO can also be used to sow soya or other crops that require large inter-row distances.

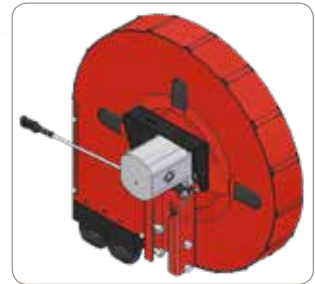

Hydraulically driven fan

Not requiring the power take-off for the operation of the fan ensures constant air flow and therefore constant transport of the seed to the ground.



LED lighting kit

Any MSD seeder now comes standard with LED lights, much more durable and brighter than previously used bulbs.



PNEUMATIC SEED DRILLS WITH FRONT TANK MSD FTC



Front LED lights are useful during transport and while seeding.

Folding ladder for tank inspection.

Parking wheels (OPTIONAL).



Electric dosage

Even the SVA ELEKTRO front tank is equipped with electrically driven metering units controlled by an X4 control monitor (standard on the MSD FTC).

The electrical transmission of the new metering units makes it possible to automate their calibration before starting to work on field.

The X4 monitor allows the electric metering units to vary the application rate during work; it also acts as a hectare counter and is set up to exclude each of the 4 seeding sections. In addition to controlling the tramline function, it can independently manage PRESTART and PRESTOP. This last function allows to perfectly seed the whole field surface, edges included.



X4 monitor functions

- Seeding check alarm
- Partial and total hectare counter
- Working speed
- Blower RPM sensor
- Seed level sensor
- Tramline set-up
- Section excluder set-up
- Seeder PRESTART, PRESTOP

SVA ELEKTRO Front tank

The 1800 L SVA ELEKTRO front tank can be used to supply seeds to the MSD FTC and MSD COMBI FOLDING seed drill. Its total capacity can reach 2200 L using tank extensions (OPTIONAL).



MODEL	 SIZE (AXBXC)	WEIGHT	CAPACITY
	(cm)	(kg)	(L)
SVA ELEKTRO	234x160x137	400	1800

MSD FTC With front tank

Designed thinking of those who want to increase productivity but don't necessarily want to change tractor. For an equal working width, the MSD FTC with its front tank requires less horsepower for the same working width and keeps the tractor more balanced than the MSD ELEKTRO.

Available with working widths of 5.0 and 6.0 m and a minimum standard row spacing of 12.5 cm. The 4 metering units placed on the front tank are driven by an electric motor and controlled by the X4 seeding monitor. This monitor allows the seeding investment to be varied quickly by setting the desired value and also controls the seed flow for each section. The tramline and section control functions are optional and integrate with the X4 monitor.



MODEL	N° OF ROWS	ROW SPACING	TOOLBAR	WEIGHT			REQUIRED POWER	CAPACITY SEED	PRODUCTIVITY
				DISC	DISC + PRESS WHEEL	DOUBLE DISC + PRESS WHEEL			
		(cm)	(cm)	(kg)			(hp)	(L)	(ha/h)
MSD FTC 50	32	15.0	270/500	1640	1830	1890	90	1800	4.4
MSD FTC 50	36	13.9	270/500	1690	1910	1990	100	1800	4.4
MSD FTC 50	40	12.5	270/500	1750	1990	2080	110	1800	4.4
MSD FTC 60	40	15.0	270/600	1760	2000	2120	110	1800	5.6
MSD FTC 60	44	13.6	270/600	1820	2080	2220	110	1800	5.6
MSD FTC 60	48	12.5	270/600	1870	2160	2310	120	1800	5.6

Row marker

Hydraulic row marker.

Distribution heads

Pneumatic transportation and 4 distribution heads for an even distribution of the seed across the whole working width.



Available planting units



Single disc unit with working depth control.



Single disc unit and seed pressing/ depth control wheel.

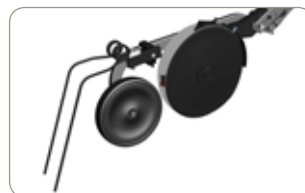

Double disc unit and seed pressing/ depth control wheel.



SEED DRILL COMBINED WITH POWER HARROW MSD COMBI

Pneumatic fan hydraulic drive, tractor dependent.
The required continuous oil flow is 40 L/Min with direct back-flow to the tank.

Seed tank
Large tank 1300 L, with 2 metering units (3.0 m), with 4 metering units (3.5-4.0 m).

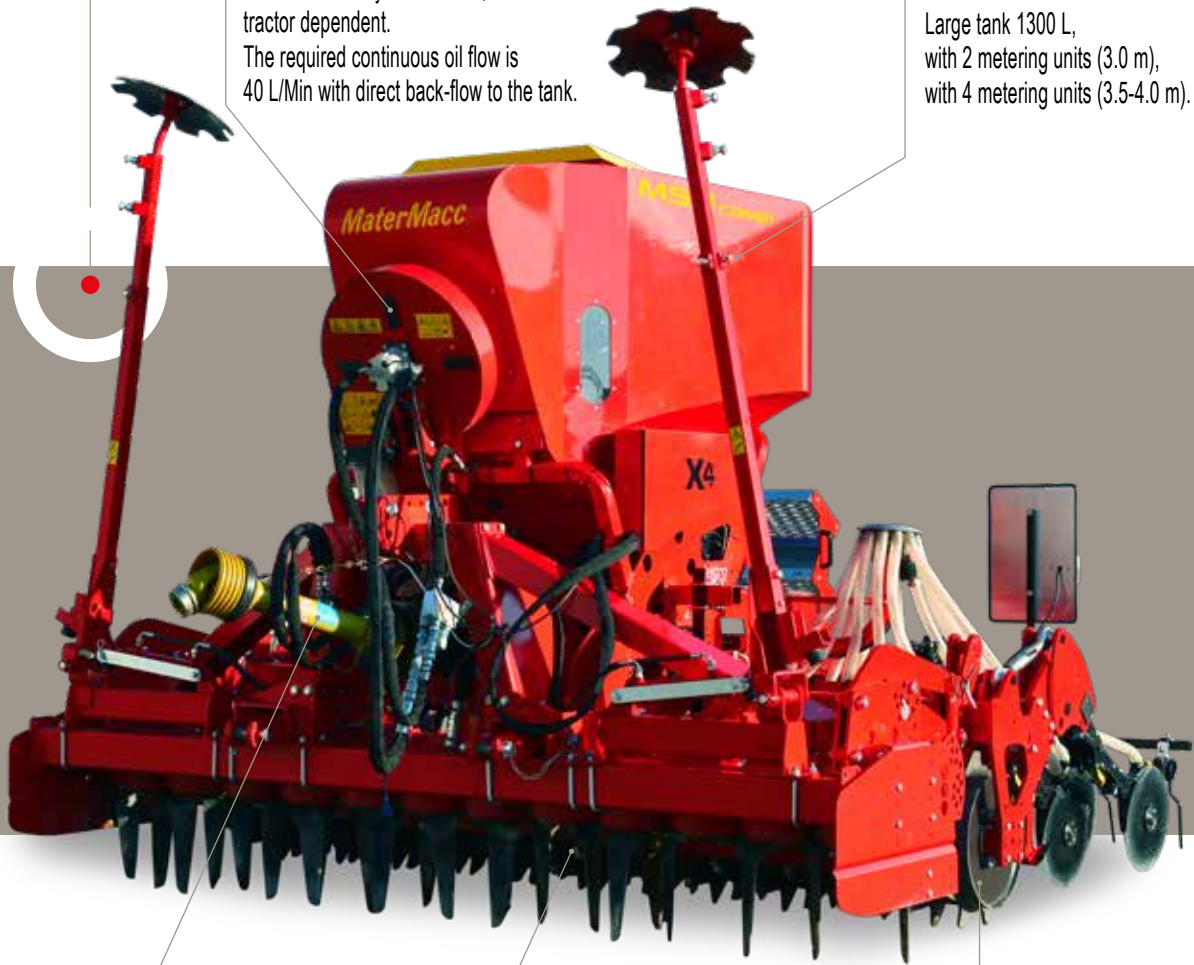

PTO shaft with cam clutch (STANDARD).

MK
Power harrow model MK 180, MK 270.

PACKER roller Ø 550 mm.



Available planting units



Single disc unit with working depth control.



Single disc unit and seed pressing/ depth control wheel.

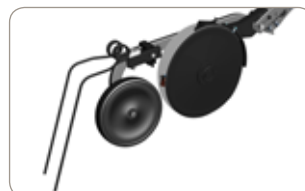

Double disc unit and seed pressing/ depth control wheel.

MSD COMBI

The MSD COMBI seeder is particularly compact to reduce the strain on the lifter to a minimum, thereby reducing the extent to which the ground is compacted down.

Combined MaterMacc seeders allow you to prepare, level the ground and prepare a good seedbed so as to be able to sow in one go. This versatile machine reduces operating times.

Row marker

Hydraulic row marker (OPTIONAL).



GPS aerial for speed detection.



Electrical button for the distribution test.



LED transport lights and reflection panels.

Loading platform with step-ladder.



Monitor X4

This monitor allows to change the seeding investment quickly by setting the desired value, it also controls the seed flow for each section. The tramline and section control functions are optional and are integrated in the X4 monitor.

The MSD COMBI can be transformed into an ISOBUS machine (optional) and controlled with the tractor terminal*.

(* Task Control functionalities can vary depending on the brand of virtual terminal connected.

MK Power harrow

Supplied exclusively in combination with the seed drill.

To ensure excellent performance even in difficult conditions where there are crop residues, our machines are designed and built with an optimal distance between the tooth-holder support and the harrow box.

This means a significant amount of residue and any stones can pass through easily, avoiding running into troublesome blockages. The tines on the harrow also ensure optimal penetration even into difficult terrain, maintaining a constant working depth.

The Paker roller with a diameter of 550 mm is suitable for medium-to-hard terrain; it is extremely versatile and ideal to be used in combination with the MSD ELEKTRO seeder.

2 different power harrows, MK 180 for up to 180 hp, MK 270 for up to 270 hp, both with orientable roller bearings.

As an optional, all harrows can come with Quick-Fit blades.



MODEL	N° OF TINES	WORKING DEPTH	WIDTH		PTO RPM		REQUIRED POWER	WEIGHT
			WORK	TRANSPORT	540	1000		
		(cm)	(cm)		(min ⁻¹)		(hp)	(kg)
MK 180/300	24	10-30	294	300	350	359	100-180	1468
MK 270/300	24	10-32	294	300	-	365	150-270	1530

Spherical roller bearings

New shielded bearings more resistant to high radial and axial loads for increased reliability and durability under severe operating conditions.

Their high load capacity and ability to compensate for misalignment help extend bearing life by almost three times.

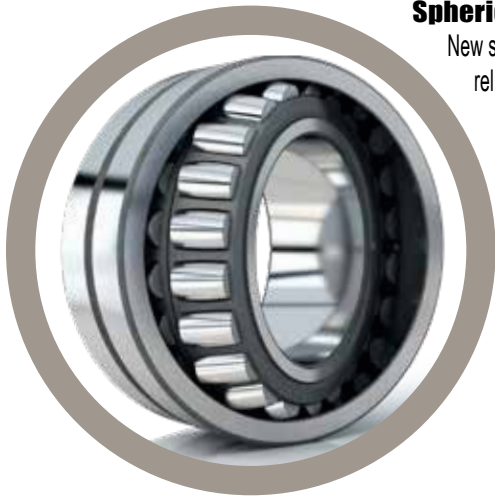

Oversized and adjustable bulkheads

The larger size of the containment bulkheads and the possibility of adjusting their position allows the quality of harrowing to be optimised down to the last centimetre of the working width.

Power harrow accessories



Kit rigid track eradicator.



Kit NO STOP spring track eradicator.



Quick-Fit blades.

MSD COMBI

Seed drill combined with power harrow.

Pneumatic seed drill for sowing in rows for cereals, rapeseed, soy, alfalfa and other forage. Three possible row spacings starting from 12.5 cm (standard).

The seed distributors are powered by an electric motor and controlled by the MaterMacc X4 monitor.

The Packer roller not only stabilises the seeder and tractor considerably, but also acts as an important reference point to ensure constant seeding depth.



MODEL	N° OF ROWS	ROW SPACING	TOOLBAR	WEIGHT			REQUIRED POWER	CAPACITY SEED	PRODUCTIVITY
				DISC	DISC + PRESS WHEEL	DOUBLE DISC + PRESS WHEEL			
		(cm)	(cm)	(kg)			(hp)	(L)	(ha/h)
MSD-C 300/180	18	16.6	300	2290	2360	2400	140	1300	1,1
MSD-C 300/180	20	15.0	300	2320	2400	2450	140	1300	1,1
MSD-C 300/180	24	12.5	300	2390	2480	2540	140	1300	1,1
MSD-C 300/270	18	16.6	300	2370	2430	2470	180	1300	1,5
MSD-C 300/270	20	15.0	300	2400	2470	2520	180	1300	1,5
MSD-C 300/270	24	12.5	300	2460	2550	2610	180	1300	1,5





PNEUMATIC SEED DRILL COMBINED WITH A POWER HARROW & FOLDING TOOL BAR

MSD COMBI FOLDING



PACKER roller Ø 550 mm.

MK
Folding power harrow with 5.0 and 6.0 m working width.
Quick-Fit blades available as optional.



Available planting units



Single disc unit with working depth control.



Single disc unit and seed pressing/ depth control wheel.

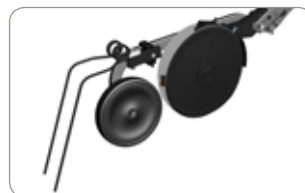

Double disc unit and seed pressing/ depth control wheel.

MSD COMBI FOLDING

The MSD COMBI FOLDING with hydraulically folding toolframe has a road transport width of just 2.54 m, with a working width of 5.0 and 6.0 m. Combined MaterMacc seeders allow you to prepare, level the ground and prepare a good seedbed so as to be able to sow in one go. This versatile machine reduces operating times.

Tractor-dependent hydraulic fan drive. Continuous oil flow of 40 L/min with direct oil return to tank is required.

SVA ELEKTRO tank

The 1800 L front tank holds its own fan and an inspection ladder.

Power arrow adjustments

The power harrow is highly versatile, working depth and overall setup can be adjusted according to your particular needs. In addition, the seeding bar depth adjustment system is independent from that of the power harrow.



Height-adjustable leveling bar to further crush and level the soil.

Working depth control by pin adjustment.



Row marker
Hydraulic row marker (OPTIONAL).

MK Power harrow

Supplied exclusively in combination with the seed drill.

Powerful, sturdy and rigid, the power harrows we combine to our seed drills are designed for maximum resistance to torsional forces to allow the internal components to work perfectly in line, even after years of heavy use.

The results are excellent on both ploughed and hard-packed soils with little crop residue present.

The MK harrow is fitted with a 550 mm diameter Paker roller, suitable for medium to hard soil, very versatile and ideal to be combined to our MSD ELEKTRO seed drill.

Both these two power harrows have hydraulically folding toolframes and are equipped with Quick-Fit blades, safety hooks and mechanical floating system.



Some possible configurations

MODEL	N° OF TINES	WORKING DEPTH (cm)	WIDTH (cm)		PTO RPM 1000 (min ⁻¹)	REQUIRED POWER (hp)	WEIGHT (kg)
			WORK	TRANSPORT			
MK 260/500	40	10 - 30	496	250	310/352	160-260	2900
MK 350/600	48	10 - 30	592	250	324/363	220-350	3590



Spherical roller bearings

The MK 350/600 power harrow uses shielded spherical roller bearings that are more resistant to high radial and axial loads for increased reliability and durability under severe operating conditions.

Their high load capacity and ability to compensate for misalignment help to extend bearing life by almost three times.

Power harrow accessories



Rigid track eradicator kit.



NO STOP spring track eradicator kit.



Oversized and adjustable bulkheads

The larger size of the containment bulkheads in the MK 350/600 and the possibility of adjusting their position allows the quality of harrowing to be optimised down to the last centimetre of the working width

MSD COMBI FOLDING

Seed drill combined with power harrow.

Reduce field entry and soil compaction while preserving soil fertility with this folding combination. Available working widths are 5.0 m or 6.0 m with a minimum row spacing of 12.5 cm (standard).

The front seed tank helps to balance the tractor.

The seed drill, derived from the MSD ELEKTRO model from which it inherits both the distribution system and the electronic control system via the X4 terminal, can also be supplied individually so that customers can combine it with their own harrow.



MODEL	N° OF ROWS	ROW SPACING MAX.	TOOLBAR	WEIGHT			REQUIRED POWER	CAPACITY	PRODUCTIVITY
				DISC	DISC + PRESS WHEEL+	DOUBLE DISC PRESS WHEEL			
		(cm)	(cm)	(kg)			(hp)	(L)	(ha/h)
MSD CF 500	32	15.0	254/500	3800	3930	4000	180	1800	2,1
MSD CF 500	36	13.6	254/500	4000	4130	4200	180	1800	2,1
MSD CF 500	40	12.5	254/500	4300	4430	4500	180	1800	2,1
MSD CF 600	40	15.0	254/600	4600	4730	4800	240	1800	3,1
MSD CF 600	44	13.6	254/600	4900	5030	5100	240	1800	3,1
MSD CF 600	48	12.5	254/600	5200	5350	5400	240	1800	3,1



Compact, yet voluminous

The new SVA ELEKTRO front tank offers a high loading capacity (up to 2200 litres with the optional extension) while remaining compact.

The careful design of the shape and volume of the SVA ELEKTRO safeguards the operator's visibility while maintaining high tractor manoeuvrability and offering a high capacity hopper.



Function monitor X4

- Seeding check alarm
- Partial and total hectare counter
- Working speed
- Blower RPM sensor
- Seed level sensor
- Tramline set-up
- Section excluder set-up
- Seeder PRESTART, PRESTOP

PNEUMATIC SEED DRILLS MINIMUM TILL & NO-TILL UST

Tank

Seed and fertilizer tank with loading platform.
Total capacity 3000 L (2000 L for seed, 1000 L for fertilizer).

Blower

Hydraulic blower for pneumatic seed transportation (40 L/min).



Seed and fertilizer metering unit

Volumetric and independent seed and fertilizer metering unit with divided distribution for each seeding row.

Road transport wheels

Low pressure transport wheels
700/50-R22.5

Compression wheels

Compression roller to adjust depth, with 17x8.00-R8 low-pressure wheels in correspondence with every coulter.



Planting unit carriers

Planting units fitted on independent, floating carriers. The system allows you to follow the edge of the land, uniformly distributing the load via a hydraulic system.



Depth gauge wheels

Front wheels 26x12-12 low pressure, to adjust the seed depth.



Planting unit

Optimal planting units distance, on 5 ranks.
Clearance from the ground of 600 mm allowing optimal flow of the crop residue.

Tool bar

Foldable frame for transportation on the road.
Transport width shorter than 3.0 m.

Tractor linkage

3-point hitch, II and III cat.,
with rotation joint.

UST Pneumatic seed drills minimum till & no-till

The UST Air Seeders - Under Surface Seeding Technology are developed for conservation tillage sowings of all kind of winter cereals, OSR, forage seeds and cover crops.



MODEL	N° OF ROWS	ROW SPACING	TOOLBAR	WEIGHT	REQUIRED POWER	CAPACITY		PRODUCTIVITY
						SEED	FERTILIZER	
		(cm)	(cm)	(Kg)	(hp)	L		(ha/h)
UST 450	15	30	290/450	4280	140	2000	1000	4.6
UST 600	20	30	300/600	5200	180	2000	1000	6,5

Safety bolts: the connection system ensures protection of the planting unit from stones and other debris.

Mechanical jack to change the inclination angle of the planting unit.



Each seed line is prearranged with a photocell to control the flow and prevent any obstructions from forming.

Articulate parallelogram to follow the soil profile.

SEED
Fertilizer

Push rod with tungsten carbide insert for a long-term duration.

Seed/fertilizer diffuser.

23 cm wide wing-shaped tungsten carbide coated working element.

Sequence of introducing the planting unit into the ground



Agronomic advantages of conservative agriculture through the UST seeder

- Reduction of disturbance to the soil improving the structure of the terrain and increasing the mineralisation of the organic substance, facilitating the development of organisms and other benefits.
- Ground protection of the ground from erosion and no waste of mineral nutrients.
- Increase in the moisture retention capacity of the soil
- Nutrient elements available from the first stage of development with subsequently less need for fertilizers in the crop growing phase.
- Better water drainage and more rapid growth of crops
- Effective mechanical control of weeds



The UST planting unit with little wings (patented) allows getting a furrow by raising a layer of soil. This layer then drops off over the seed after the passage of the planting unit. This technology enables the seed to be planted without any contact with soil remains. Moreover, the little wings grant an efficient mechanical weeding.

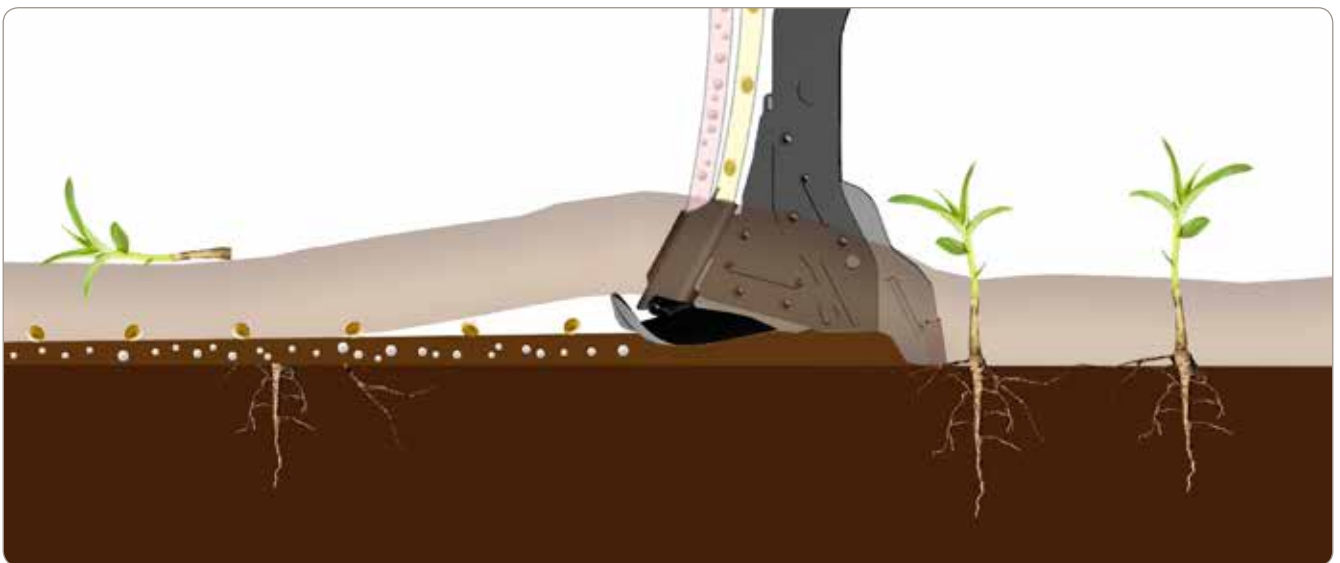

The sowing unit keeps the crop residue at the surface in order to prevent them to contact the seed inside the furrow; effective mechanical control of weeds.

Advantages compared to no-till sowing with a double disc coulters

Less power used and reduced consumption

For the same working width, the UST drill requires less pulling power due to the number of coulters units used. A lower power requirement translates into lower fuel consumption

Parts subjected to wear

The complex disc coulters system of no-till seed drills involves considerable wear parts on working elements and involves many spare parts that are necessary to maintain properly. Thanks to the simple design of the UST drill's coulters unit, however, spare parts are few and inexpensive.

In terms of agronomics

The disc coulters system risks excessively compacting the soil in the newly opened furrow, limiting the development of the root system and stunting plant growth. The UST coulters exploits its front "beak" not only to create a furrow in which to deposit the fertiliser but also to increase the disintegrating action and deposit the seeds in a strip of soil that has been broken up even in depth.

Row spacing available

The bilateral seed diffuser and the 30 cm distance between the centre points of the coulters makes different seed row spacing possible. Below are some examples.

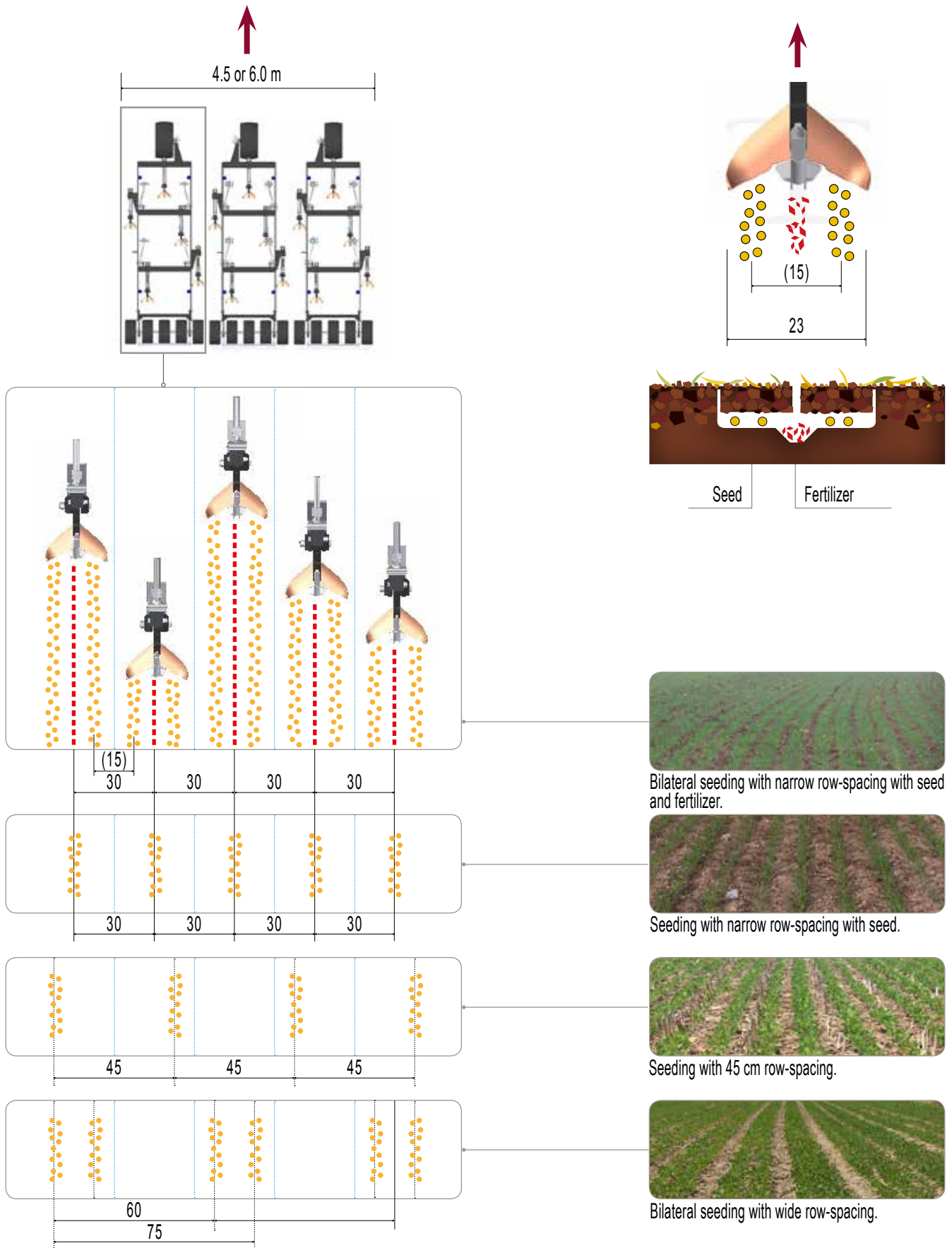

Version available with different row distances, obtained by the exclusion of outlets, planting metering units or planting units.

Economic advantages

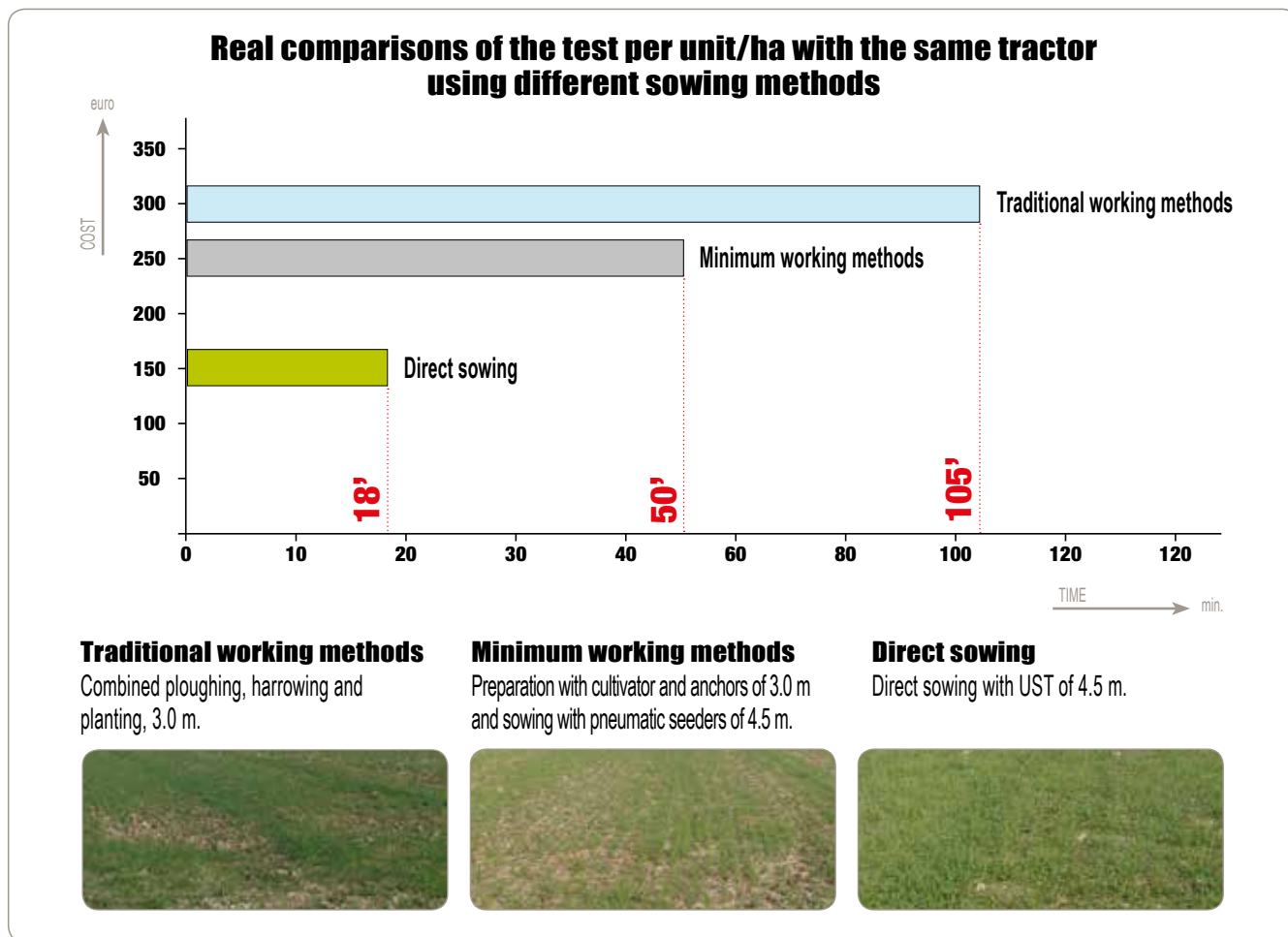

Economic benefits provided by the UST seeder

Time

Time saved always translates into money, eliminating ploughing, harrowing, work with disc harrows and the preparation in general of the land for sowing means saving an average of 50% compared to traditional working methods and approximately 30% when compared to minimum working methods.

Spare parts

The UST seeder has a maintenance cost per Ha which is extremely low thanks to the small number of parts which are subject to wear.

BIO Crops

The UST no-till sowing which is also used for BIO crops facilitates the growth of the root system of specific plants.



Versatility

The versatility of the UST allows most existing crops to be sown such as soya, cereals, forage, cover crop. For this reason it can be defined as a universal seeder.



MONITOR	MODEL	FUNCTION
 <p>ISOBUS (*)</p>	<p>MSD MSD ELEKTRO MSD FTC MSD COMBI MSD COMBI FOLDING UST</p>	<p>Seeding control system based on ISOBUS standard (ISO 11783). Fully compatible with most tractor/monitor with ISOBUS technology.</p> <ul style="list-style-type: none"> - Seeding rate visualization - Manual or tramline based (OPTIONAL) row crop exclusion (not available for UST)
 <p>X25</p>	<p>MSD MSD ELEKTRO MSD FTC MSD COMBI MSD COMBI FOLDING UST</p>	<p>Kit VIRTUAL TERMINAL ISOBUS X25 (touchscreen 8")</p> <ul style="list-style-type: none"> - Remote support for technical assistance - Full capability to map and manage data - Bright, sunlight readable multi-touch display, with information boxes that can be re-positioned - Easy to install on the most common vehicles on the market, in manual and autonomous drive mode - Possibility to export map of boundaries, coverage, applications record - UT ISO and TC ISO completely integrated - TC-SC available - GPS receiver SGR-1 supplied (accuracy: 20 cm)
 <p>X35</p>	<p>MSD MSD ELEKTRO MSD FTC MSD COMBI MSD COMBI FOLDING UST</p>	<p>Kit VIRTUAL TERMINAL ISOBUS X35 (touchscreen 12")</p> <p>VIRTUAL TERMINAL X35 offers the same functions of X25, plus some:</p> <ul style="list-style-type: none"> - Horizon XTEND: allows to visualize on any mobile devices - Variable rate control (VRC) up to 8 products - Standard GNSS if connected to receivers SGR-1/AGI-4 - Autonomous section control (ASC) for a maximum of 200 sections - UT, TC-BAS, TC-GEO and TC-SC available - Possibility to connect up to 6 cameras - GPS receiver SGR-1 supplied (accuracy: 20 cm)
 <p>MONOTRONIC 32</p>	<p>UST</p>	<ul style="list-style-type: none"> - Seed flow check on each row - Partial and total hectare counter - Working speed

(*) Functions (Task controls) may vary according to the VIRTUAL TERMINAL connected to the tractor.

MONITOR	MODEL	FUNCTION
 <p>X4</p>	<p>MSD MSD ELEKTRO MSD FTC MSD COMBI MSD COMBI FOLDING</p>	<ul style="list-style-type: none"> - Seeding check alarm - Partial and total hectare counter - Working speed (from GPS) - Blower RPM sensor - Seed level sensor - Tramline set-up - Section excluder set-up - Seeder PRESTART, PRESTOP
 <p>CNT7</p>	<p>GRANDGRANO-F GRANDGRANO-XF</p>	<ul style="list-style-type: none"> - Hectare counter - Working speed





MATERMACC S.p.A.

Z.I. Ponte Rosso, Via Gemona 18
33078 San Vito al Tagliamento (PN) • Italy
Tel. +39 0434 85267 • Fax +39 0434 85517
E-mail: info@matermacc.it

www.matermacc.it



For reasons of graphic layout and clarity, some of the pictures and images do not show the mounted “CE” protections. The technical data and models presented in this catalogue are not in any way binding. We reserve the right to change specifications without prior notice.

MaterMacc Social



DEALER

WHERE WE ARE

EUROPE

Italy - Spain - Portugal - France - UK - Belgium - Netherlands - Switzerland - Germany - Austria - Slovenia - Croatia - Poland - Czech Republic - Slovakia - Hungary - Serbia - Romania - Bulgaria - Ukraine - Albania - Greece - Lithuania - Latvia - Estonia - Turkey

NORTH AMERICA

Canada - United States - Mexico - Guatemala - Nicaragua - Costa Rica - Dominican Republic

SOUTH AMERICA

Venezuela - Colombia - Perù - Bolivia - Chile - Argentina

OCEANIA

Australia - New Zealand

AFRICA

Marocco - Algeria - Libya - Egypt - Mali - Chad - Sudan - Ethiopia - Somalia - Kamerun - Ghana - Angola - Namibia - Sud Africa

ASIA

Russia - Belarus - Kazakhstan - Uzbekistan - Mongolia - China - Georgia - Iran - Vietnam - Japan - Korea - Indonesia - Pakistan - India